

K1400-K2200



OPERATORE IRREVERSIBILE
PER CANCELLI SCORREVOLI



- Dotato di centrale di comando incorporata, con partenza graduale, regolatore della forza elettronico, rallentamento in accostamento e freno elettronico (di serie).
- Tutta la serie K è dotata di rallentamento del cancello in accostamento, dando al movimento una sensazione di ancora maggior sicurezza e fluidità.
- Sblocco manuale con chiave personalizzata.
- Le versioni con quadro L1-CRX possono montare la sonda termica ACG4665 per mantenere il motore caldo anche a -30° C e sono dotati dell'autotest delle fotocellule come richiesto dalla norma EN12453.
- Gli operatori K sono ora disponibili anche nella versione con finecorsa magnetico, allo stesso prezzo della versione con finecorsa elettromeccanico.





PER CANCELLI SCORREVOLI PESANTI FINO A 1400 kg

AA31140	K1400 FCE	con quadro L1-CRX, finecorsa elettromeccanici	875 €
AA31142	K1400 FCM	con quadro L1-CRX, finecorsa magnetici	875 €
	AD31140	KIT K1400 FCE (fino a 1400 kg)	1.038 €
	AD31142	KIT K1400 FCM (fino a 1400 kg)	1.038 €



PER CANCELLI SCORREVOLI PESANTI FINO A 2200 kg

AA31150	K2200 FCE	con quadro L1-CRX, finecorsa elettromeccanici	1.145 €
AA31152	K2200 FCM	con quadro L1-CRX, finecorsa magnetici	1.145 €
	AD31150	KIT K2200 FCE (fino a 2200 kg)	1.260 €
	AD31152	KIT K2200 FCM (fino a 2200 kg)	1.260 €



GAR0012	Estensione garanzia 4 anni per K1400 e K2200	90 €
GAR0013	Estensione garanzia 7 anni per K1400 e K2200	160 €

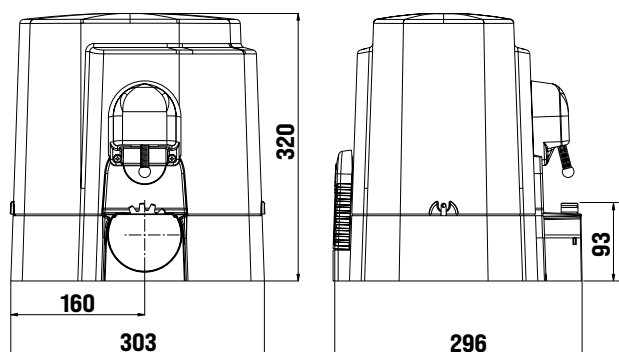

24 x



Dimensioni in mm

CARATTERISTICHE TECNICHE		K1400	K2200
Peso max cancello	Kg	1400	2200
Velocità di traino	m/s	0,16	
Forza di spinta a giri costanti	N	790	1150
Coppia max	Nm	27	39
Alimentazione	V	230	
Assorbimento	A	1,18	1,1
Cremagliera modulo		4	
Peso operatore	Kg	15	16
Grado di protezione	IP	44	
Temperatura di lavoro	°C	-10 ÷ +55	
Cicli giornalieri consigliati		400	500
Servizio	%	70	
N° cicli consecutivi garantiti		15/10m	15/10m

ACCESSORI PER K1400-2200



ACG4665 SONDA
per riscaldamento motore
(per partenze immediate con
temperature rigide) **26 €**



ACG5460 SET PLUS
Encoder per rilevare gli ostacoli
durante le manovre di apertura e
di chiusura. **29 €**



135



ACG8081 Schede di
sincronizzazione dei comandi e
delle sicurezze di 2 K
Sincronizzazione attivabile solo
con App RIB GATE **82 €**



**ACG8672 SERRATURA DI SBLOCCO
CON CHIAVE ESAGONALE**
19 €

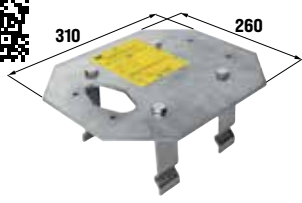

ACG8107 PIASTRA DI FISSAGGIO da
interrare **51 €**

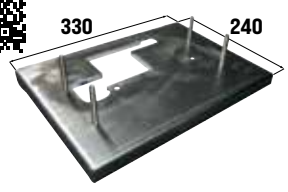

ACG8118 PIASTRA DI FISSAGGIO
adattatore piastra CAME BX per
K1400-K2200 **69 €**



ACS9020 CREMAGLIERA M4
in metallo (sez. 22 x 22 mm)
(fino a 4000 kg)
in barre da 2 m **al m 26 €**



ACS9040 CREMAGLIERA M4
in metallo (sez. 22 x 22 mm)
con angolare 45x30mm
(fino a 4000 kg)
in barre da 2 m **al m 42 €**



ACS9050 CREMAGLIERA M4
in metallo (sez. 22 x 22 mm)
rivestita con CATAFORESI,
con angolare 45x30mm
(fino a 4000 kg)
in barre da 2 m **al m 48 €**



ACS9021 CREMAGLIERA M4
in metallo (sez. 30 x 12 mm) con
distanziali tondi
(fino a 2.000 kg)
in confezione di 4 barre da 1 m
al m 18 €



K-FCE



K-FCM



KIT K1400-2200
Vedi pagina 107

a partire da 1.038 €